

INSTALLATION GUIDE FOR **FLEXI-LINE T & T3**

VEX-FLEXI-LINE-T
VEX-FLEXI-LINE-T3



Please ensure you have read the following instructions thoroughly and can undertake the required actions before commencing installation.

If you have any queries, please consult our Technical Support Department before proceeding.

Contents

Scope.....	2
Revision History.....	2
Installation Instructions:.....	3
Stainless Steel Mounting Clips.....	4
Mounting Profile.....	5
Adjustable Bracket.....	6
Silicone Mounting Clips.....	7
Wiring.....	8
Single Colour.....	8
RGB.....	8
Extending Vexica Standard Input Cables.....	9
Cautions:.....	10

Scope

This manual will detail the installation of a Flexi-Graze luminaire.

Revision History

Rev	Date	Comment	Author
A	11/03/2024	Document created	JP

Approved By

Person	Date	Signature
Technical Manager		

Installation Instructions:

Please read these instructions carefully before installation and make sure you fully understand them. Pay attention to how the luminaire is wired. If you require any further guidance, please contact Vexica.

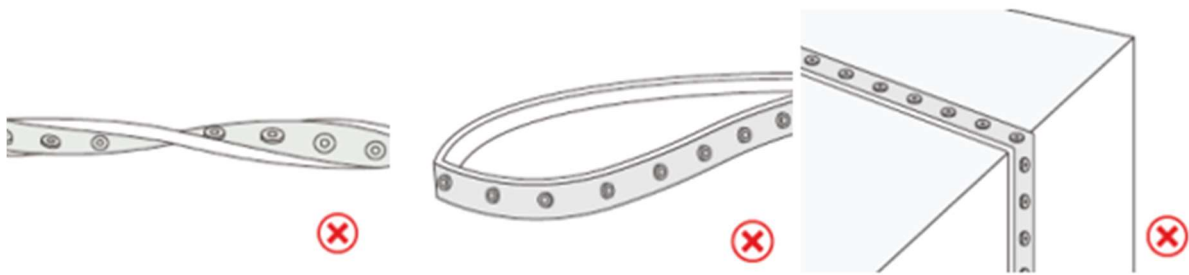
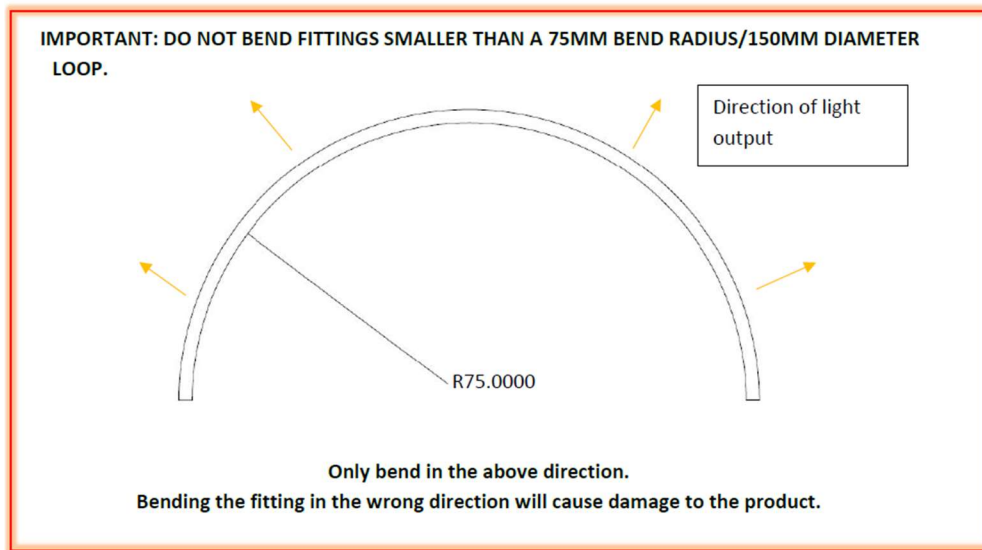

When installing the Flexi-Graze DO NOT twist, fold or bend sharply, all of these actions will damage the product.

There are four mounting options for the Flex-Graze. Stainless steel mounting clips, mounting profile, plastic mounting clips and adjustable brackets. These instructions cover all installation types.

Stainless Steel Mounting Clips



Fix mounting clips to the required surface using appropriate screws (Vexica do not provide these as the type and size depends on the surface luminaire is mounted to). Press the Flexi-Graze into the mounting clip, avoiding applying pressure to the optics.

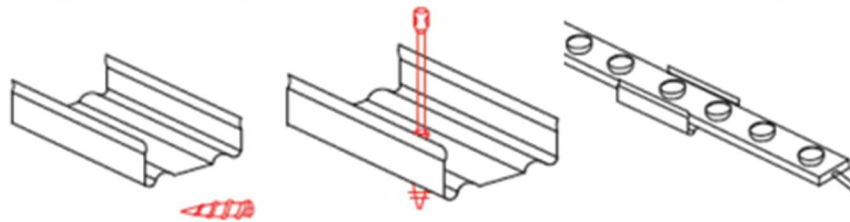

Mounting Profile



Fix mounting profile to the required surface using appropriate screws (Vexica do not provide these as the type and size depends on the surface luminaire is mounted to). Press the Flexi-Graze into the mounting profile, avoiding applying pressure to the optics.

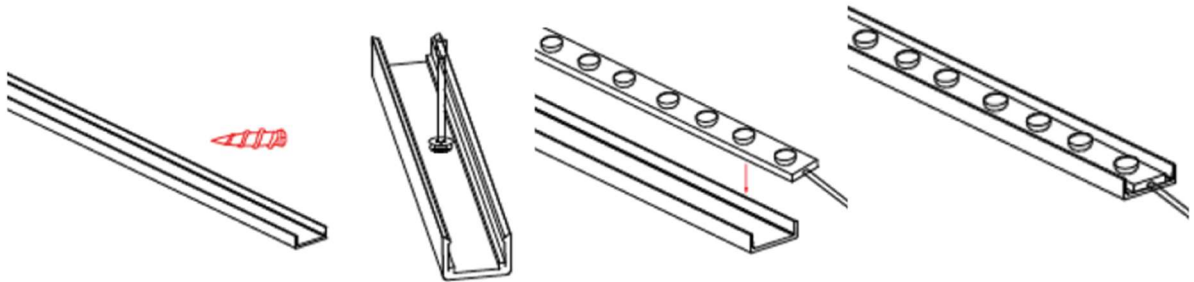

Adjustable Bracket



Using the Mounting Profile allows the use of an adjustable bracket rather than fixing the profile directly to a surface. To install with adjustable brackets fit the Flexi-Graze into the mounting profile, avoiding applying pressure to the optics. Fix mounting brackets to the required surface using appropriate screws (Vexica do not provide these as the type and size depends on the surface luminaire is mounted to). Press the profile into the mounting clip, avoiding applying pressure to the optics. Adjust the bracket to the desired angle.

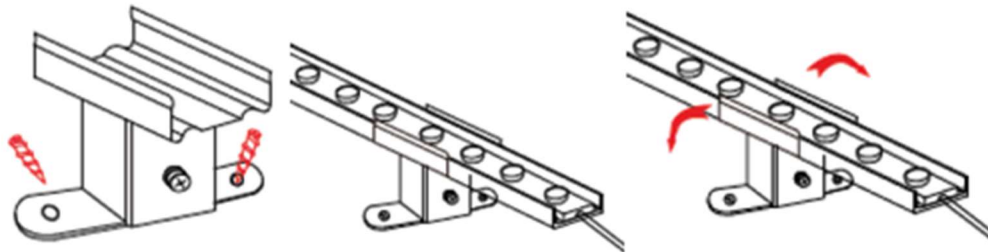

Silicone Mounting Clips

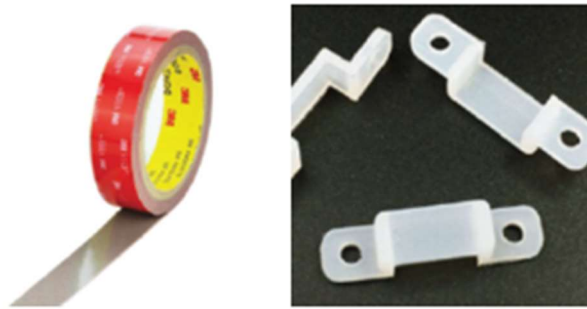

When using the silicone mounting clips, the mounting surface must be cleaned thoroughly with isopropyl alcohol to remove any grease or dirt and allowed to dry thoroughly before applying the VHB tape. Apply the VHB tape to the reverse of the Flexi-Graze along its full length and fix in place. Secure the Flexi Graze by using the silicone mounting clips

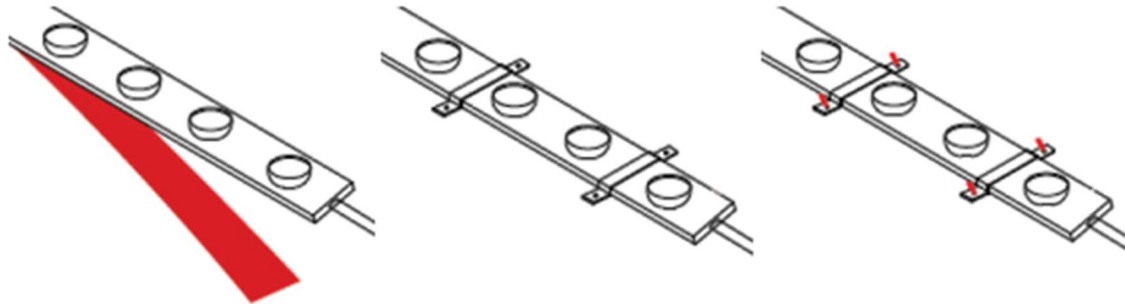

Wiring

	WARNING! Risk of electrical shock. Disconnect power before servicing or installation.	
---	---	---

Securely mount PSU/LED driver and connect starter cable following the colour coding:

Single Colour

LED Driver	Wire Colour
24VDC+	Red
24VDC -	Blue

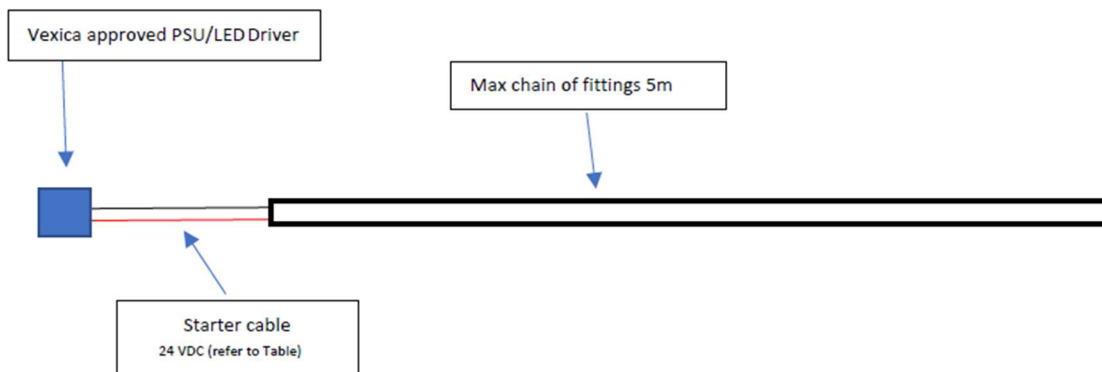

RGB

LED Driver	Wire Colour
24VDC +	Back
Red-	Red
Green-	Green
Blue-	Blue

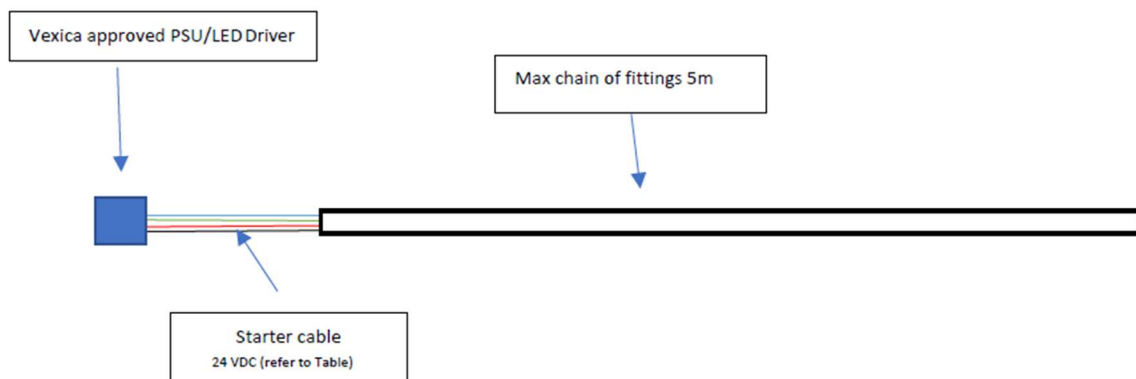

DO NOT REVERSE POLARITY

Extending Vexica Standard Input Cables

When extending cables or making any connections on-site always ensure the connection has an appropriate IP rating.

Vexica recommends the starter cables are linked to extensions cables with gel boxes. Extending sheathed cables ensures that the outer sheath is encased in the gel box to retain the IP rating.

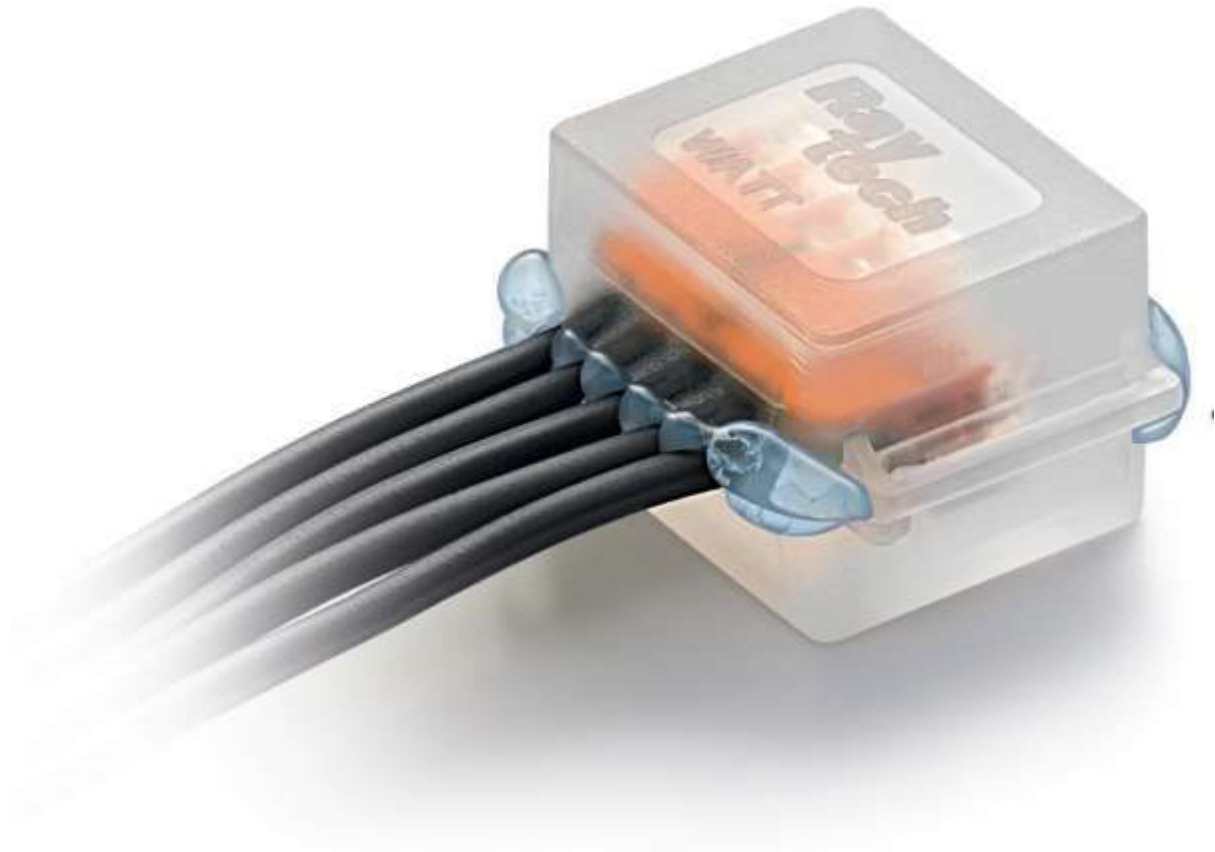

For more details visit: <http://www.raytech.it/catalogo/en/gel-box-line.pdf>

Cautions:

PLEASE TAKE NOTE OF LUMINAIRE AND DRIVER INGRESS PROTECTION RATING WHEN DECIDING LOCATION

MAKE SURE ALL CONNECTIONS MADE ARE TIGHT WITH NO LOOSE STRANDS AND WITH APPROPRIATE IP RATING.

DO NOT HOT PLUG OR REVERSE POLARITY.

ALWAYS ALLOW SUFFICIENT SLACK ON THE SUPPLY CABLE TO REMOVE LUMINAIRE FROM ITS POSITION FOR ANY FURTHER MAINTENANCE

MAKE SURE SUPPLY CABLE IS NOT IN CONTACT WITH SHARP OBJECTS DO NOT LEAVE CABLE OR ANY CONNECTOR EXPOSED TO RAIN/MOISTURE FOR ANY PERIOD.

CAUTION!

- *All images are representative and may not be of the actual product supplied depending on the ordering options.*
- *Avoid staring directly into the light beam.*
- *The product should be installed by a certified electrician and following local regulations.*
- *Take extreme care when working with mains voltages.*
- *There are no user-serviceable parts inside this unit. Do not attempt any repairs yourself, doing so will void your manufactures warranty.*
- *During operation, the housing may become hot, avoid touching the unit with bare hands while in use.*
- *Do not allow the product to operate in ambient temperatures above the maximum ambient stated on the datasheet; doing so will void any warranty.*
- *Do not use aggressive cleaning agents! Warranty will not cover any chemical damage to the seals.*
- **DO NOT "HOT PLUG" THE LED FITTINGS OR DRIVERS AS THIS WILL INVALIDATE THE WARRANTY!**