

INSTALLATION GUIDE FOR **FLEXI-LINE T & T3**

VEX-FLEXI-LINE-T
VEX-FLEXI-LINE-T3

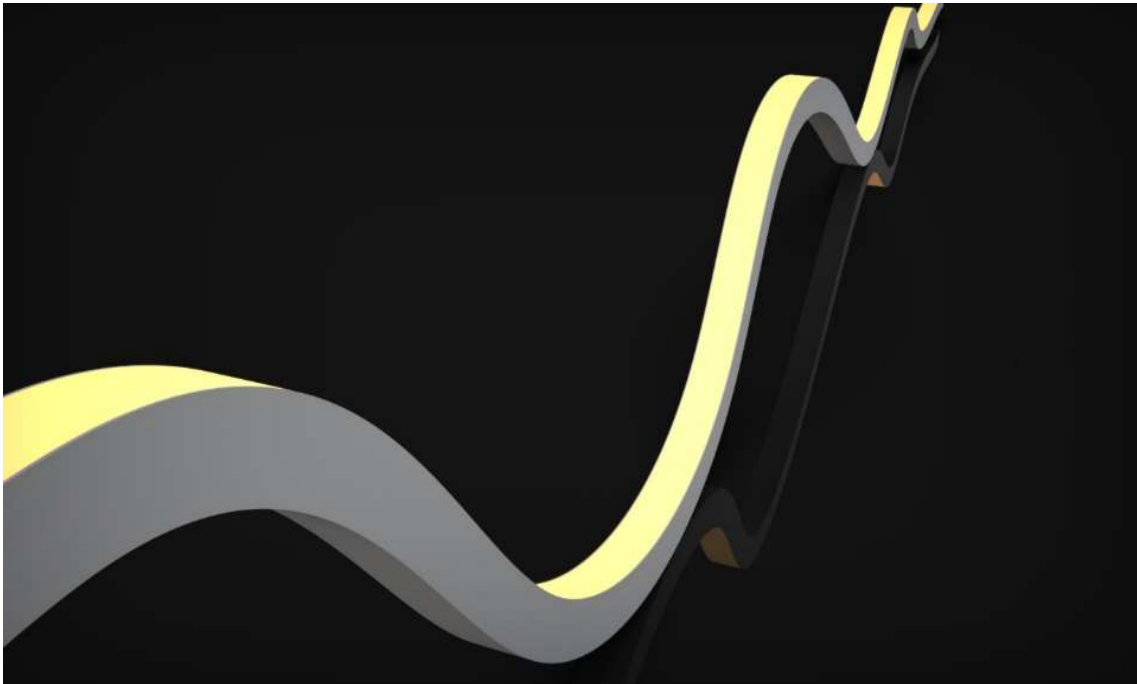

Please ensure you have read the following instructions thoroughly and can undertake the required actions before commencing installation.

If you have any queries, please consult our Technical Support Department before proceeding.

Contents

Scope.....	2
Revision History	2
Installation Instructions:	3
Installation Instructions	3
Bracket Installation	4
Tape Installation.....	5
Electrical Installation Instructions:.....	6
Wiring Information	7
Single Colour	7
Tuneable White	7
RGB – Unsheathed – JWPF 4-Way.....	8
RGB – Sheathed – SSL1.2 4-Way	8
RGB Dynamic.....	8
Important Information.....	9
Extending Vexica Standard Input Cables	10
Cautions:	11

Scope

This manual will detail the installation of VEX-FLEXI-LINE-T Single Colour, RGB, RGB DYN, Tuneable White luminaires.

Revision History

Rev	Date	Comment	Author
A	08/10/2018	Document created	MB
B	05/11/2018	Document Amended	JP
C	07/01/2020	Added Tape Mounting Instructions	JP
D	03/03/2020	Added TW Wiring	JP
E	03/08/2020	Added colour codes for 4-way SSL1.2 RGB	ST
F	16/03/2023	Added max power comment on -TW Removed RGBW	CJG

Approved By

Person	Date	Signature
Technical Manager		

Installation Instructions:

Please read these instructions carefully before installation and make sure you fully understand them. Pay attention to how the luminaire is wired. If you require any further guidance, please contact Vexica.

Installation Instructions**IMPORTANT!**

DO NOT BEND FITTINGS SMALLER THAN A 150MM BEND RADIUS/300MM DIAMETER LOOP.

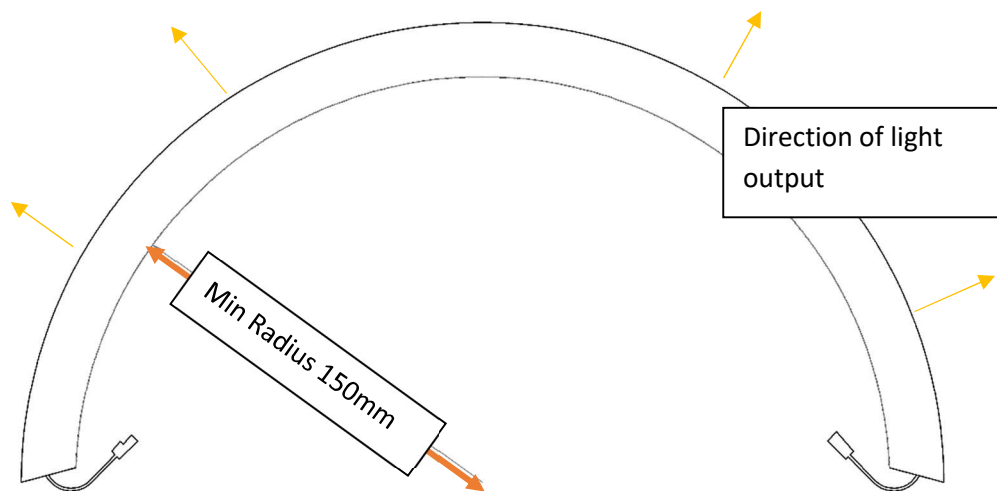

**Only bend in the above direction.
Bending the fitting in the wrong direction will cause damage to the product.**

Bracket Installation

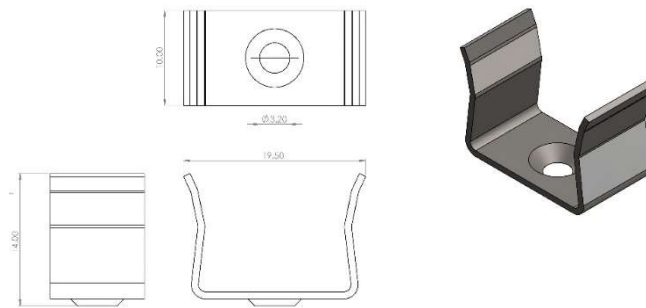

Part Code:001716

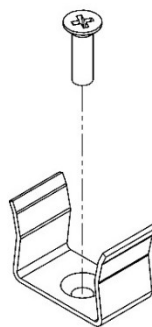

Using a suitable countersunk fixing screw (not supplied), secure the brackets down onto the mounting surface.

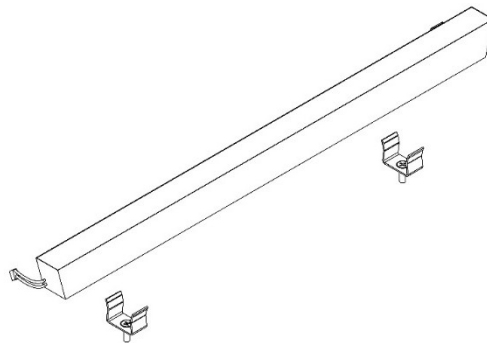

Press fitting into the installed bracket until the fitting is flush on the base on the bracket. Use 3 or 4 brackets per metre of light fittings depending on the bend radius (minimum 150mm) and site requirements.

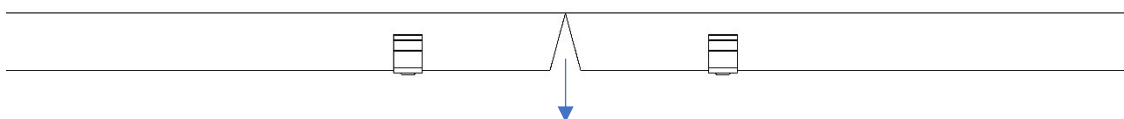

Fittings can be butted together to form a continuous line of light. Cable exit and entry shall be via the gap created due to the angle of the products.

Tape Installation

In certain applications, VEX-FLEXI-LINE-T can be mounted with tape rather than brackets. Vexica recommends 3M VHB Acrylic Foam Tape 5925F (refer to manufactures datasheet for suitability).

Bond strength is dependent upon the amount of adhesive-to-surface contact developed. Firm application pressure develops better adhesive contact and thus improves bond strength. To obtain optimum adhesion, the bonding surfaces must be clean, dry, and well unified. Typical surface cleaning solvents are isopropyl alcohol/water mixture (rubbing alcohol) or heptane. Use proper safety precautions for handling solvents.

It may be necessary to seal or prime some substrates before bonding.

- a) Most porous or fibred materials (e.g., wood) will require sealing to provide a unified surface.
- b) Some materials (e.g., copper, brass, plasticised vinyl) will require priming or coating to prevent interaction between adhesive and substrates.

VHB Joining Systems are suited for use in many interior and exterior industrial applications. In many situations, they can replace rivets, spot welds, liquid adhesives, and other permanent fasteners.

All VHB tapes should be thoroughly evaluated by the user under actual use conditions with intended substrates, especially if expected use involves extreme environmental conditions.

Electrical Installation Instructions:

WARNING! Risk of electrical shock. Disconnect power before servicing or installation.

ONLY USE VEXICA APPROVED DRIVER

- Please take note of luminaire and driver ingress protection rating when deciding location.
- Make sure all connections made are tight, with no loose strands and with appropriate IP rated connectors.
- Do not reverse polarity.
- Always allow sufficient slack on the supply cable to remove the luminaire from its position for any further maintenance.
- Make sure supply cable is not in contact with any sharp objects.
- Do not leave cable or any connector exposed to rain/moisture for any period.
- Do not exceed the maximum fitting chain length of 4.8m.
- **Do not exceed the maximum power level of the fixture. When running channels concurrently, they must be limited so the total power does not exceed the 15W/m limit.**
 - **For TW products, the white channels are capable of running at 15W/m each.**

Wiring Information

Securely mount PSU/LED driver and connect starter cable following the colour coding:

Single Colour

Red	+24 VDC
Black	GND

Table 1

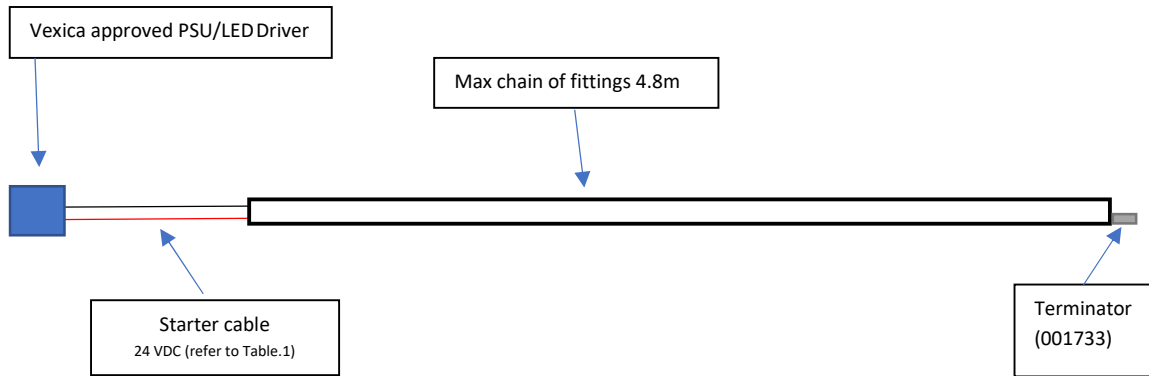

Tuneable White

Red	+24 VDC
Black	- CH 1
White	- CH 2

Table 2

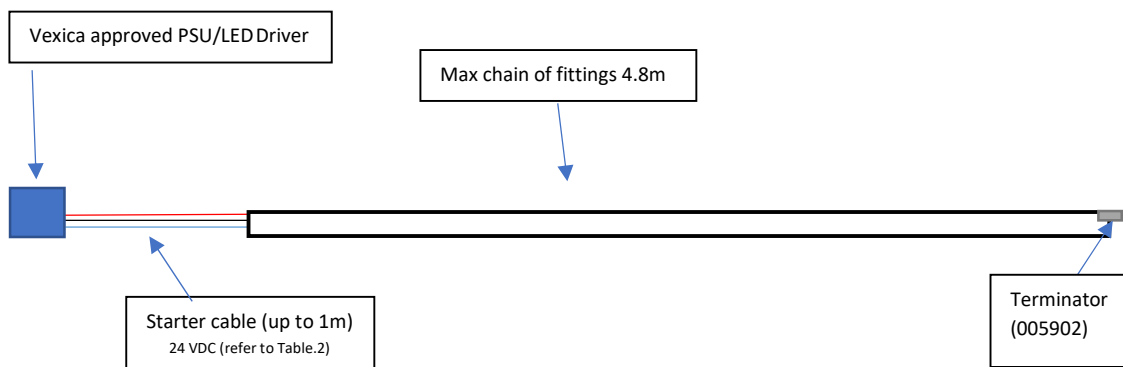

RGB – Unsheathed – JWPf 4-Way

Red	RED GND
Green	GREEN GND
Blue	BLUE GND
Black	+24 VDC

Table 3

RGB – Sheathed – SSL1.2 4-Way

Red	RED GND
Orange	GREEN GND
Yellow	BLUE GND
Brown	+24 VDC

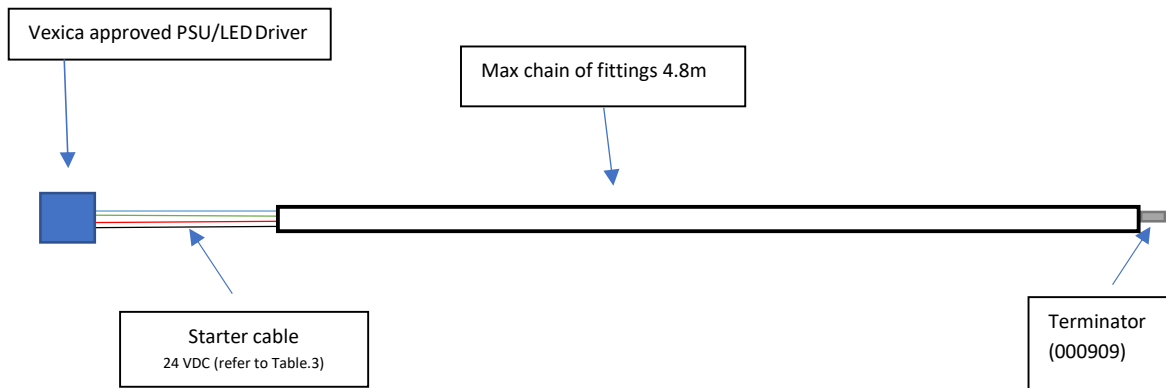

RGB Dynamic

Red	+24 VDC
White	Data
Black	-GND

Table 4

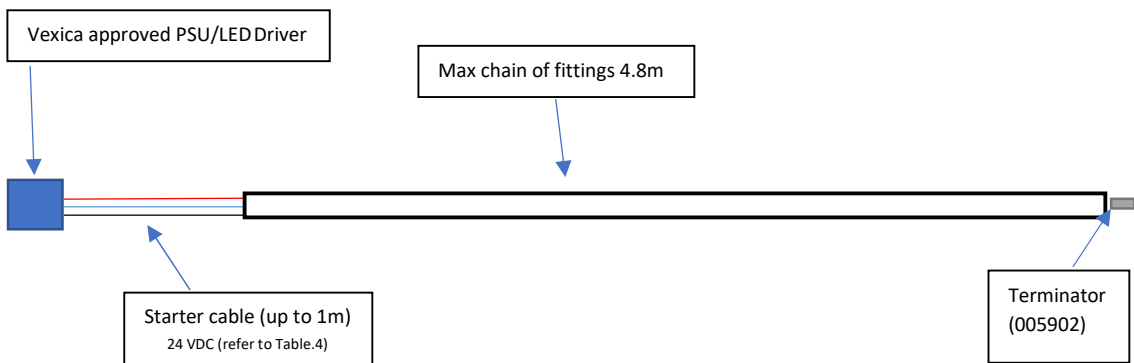

Important Information

The following information applies to the Vex-Flexible range of LED products. Take special care and follow all provided instructions to avoid any errors that may void our warranty.

All AC/DC constant current power supplies and LED drivers used are required to adhere to the following safety requirements:

- Overheat protection
- Overload protection
- Short circuit protection
- Safe extra-low voltage (SELV)
- Class SELV
- Not exceed 25 VDC output to the LED input
- Any extension cables used on the input of the LED luminaire must be terminated into an appropriate IP67 rated junction.
- All cable extensions must follow guidelines for voltage drops and proper amperage handling.
- Ensure that all electrical input feeds use Vexica original input cables only and are of female type only and are IP67 variants.
- The flexibility of the product can be highly reduced at low temperatures and therefore warming the product up to room temperature is required before installing.
- Due to best install practices, it is, therefore, best to install products at a temperature range between +18°C and 40°C.
- If the bending radius applied is too small electrical circuit damage can occur. Please follow handling instructions regarding bend orientation and radius. The minimum bend radius for all Flexible products is 150mm, a radius less than this will invalidate the warranty.

- **IMPORTANT!**

the overall maximum power level of the fixture must be kept below the 15W/m thermal threshold. Please note the maximum power stated on the product rating label; exceeding this limit will reduce the life of the product and potentially invalidate the product warranty.

For TW products, white channels are capable of running at 15W/m each. Therefore, when running channels concurrently, they must be limited so the total power does not exceed the 15W/m limit.

Extending Vexica Standard Input Cables

When extending cables or making any connections on-site always ensure the connection has an appropriate IP rating.

Vexica recommends the starter cables are linked to extensions cables with gel boxes. When using extending sheathed cables ensure that the outer sheath is encased in the gel box to retain the IP rating.

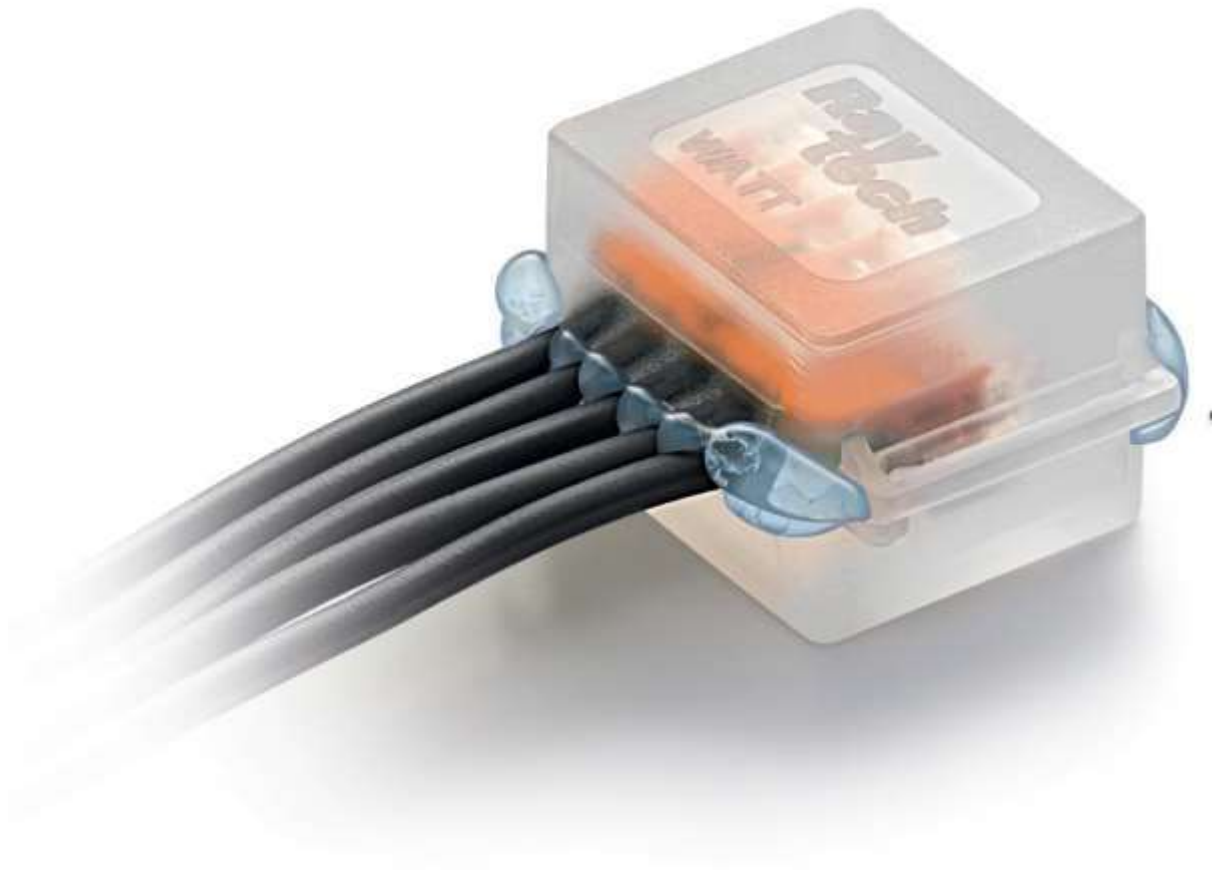

For more details visit: <http://www.raytech.it/catalogo/en/gel-box-line.pdf>

Cautions:

- *ALWAYS HANDLE LUMINAIRES WITH CARE, ENSURING ANY INPUT, OUTPUT OR CONNECTING CABLES ARE NOT SUBJECTED TO UNDUE FORCE WHICH MAY RESULT IN IRREPARABLE DAMAGE.*
- *PLEASE TAKE NOTE OF LUMINAIRE AND DRIVER INGRESS PROTECTION RATING WHEN DECIDING LOCATION*
- *MAKE SURE ALL CONNECTIONS MADE ARE TIGHT WITH NO LOOSE STRANDS AND WITH APPROPRIATE IP RATING.*
- *DO NOT HOT PLUG OR REVERSE POLARITY.*
- *ALWAYS ALLOW SUFFICIENT SLACK ON THE SUPPLY CABLE TO REMOVE LUMINAIRE FROM ITS POSITION FOR ANY FURTHER MAINTENANCE*
- *MAKE SURE SUPPLY CABLE IS NOT IN CONTACT WITH ANY SHARP OBJECTS DO NOT LEAVE CABLE OR ANY CONNECTOR EXPOSED TO RAIN/MOISTURE FOR ANY PERIOD.*

CAUTION!

- *All images are representative and may not be of the actual product supplied depending on options specified when ordering.*
- *Avoid staring directly into the light beam.*
- *The product should be installed by a certified electrician and following local regulations.*
- *Take extreme care when working with mains voltages.*
- *There are no user-serviceable parts inside this unit. Do not attempt any repairs yourself, doing so will void your manufactures warranty.*
- *During operation, the housing may become hot, avoid touching the unit with bare hands while in use.*
- *Do not allow the product to operate in ambient temperatures above the maximum ambient stated on the datasheet; doing so will void any warranty.*
- *Do not use aggressive cleaning agents! Warranty will not cover any chemical damage to the seals.*
- *DO NOT "HOT PLUG" THE LED FITTINGS OR DRIVERS AS THIS WILL INVALIDATE THE WARRANTY!*